



USER'S MANUAL

CAN-Ethernet Bridge

TRI82.002 ver 7
8 October 2011

CAN-Ethernet Bridge User's Manual

8 October 2011

©2011 Tritium Pty Ltd
Brisbane, Australia
<http://www.tritium.com.au>

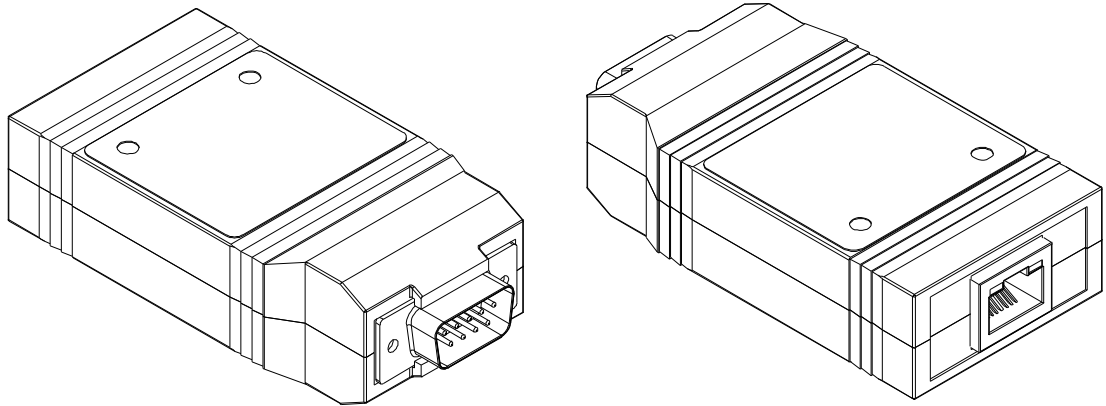

TABLE OF CONTENTS

1	Introduction.....	3
2	Overview.....	3
3	Ethernet Protocols.....	3
4	Security Considerations.....	4
5	CAN Bridge Hardware.....	4
6	User Interface.....	4
7	CAN Bridge Usage.....	4
8	Network Topologies.....	5
9	Bridge configuration.....	7
9.1	CAN-Ethernet Bridge Configuration Software.....	7
9.2	CAN-Ethernet Bridge Firmware Bootload Wizard.....	9
10	Revision Record.....	10

1 INTRODUCTION

This document describes the usage of the Tritium CAN-Ethernet bridge, including the accompanying configuration software.



2 OVERVIEW

The Tritium CAN-Ethernet bridge allows easy access to a CAN bus from a PC. No installation is required, so the device can be used with any PC with an Ethernet interface. Furthermore, an already present Ethernet network can be used to route CAN messages: with a bridge connected to a router on the network, all PCs attached to that router will become part of the virtual CAN bus. It is also possible to combine multiple physically separate CAN buses into one virtual bus, or use them as separate virtual buses on the same network.

3 ETHERNET PROTOCOLS

By default, the bridge transmits CAN message over Ethernet via multicast UDP/IP packets. This protocol provides the best match with the broadcast architecture of physical CAN networks, whereby a packet sent by one node can be received by all other nodes connected to the network.

However, UDP is an unreliable protocol, which means that messages can get lost and the order of messages can change. In general, given the relatively high bandwidth of most modern network connections, such transmission errors are rare; however, in certain applications when lossless communications are required (e.g. when transmitting data streams over CAN) the unreliable nature of UDP may not be acceptable. In these situations, it is possible for a bi-directional TCP/IP connection to be made to a particular CAN-Ethernet bridge, thereby ensuring the reliability of the virtual section of the CAN-Ethernet network. The downside of using this TCP/IP link is that by definition it is a point-to-point connection, and any data sent or received will not be visible to other nodes on the virtual network. Also, each bridge supports only a single simultaneous TCP/IP connection.



4 SECURITY CONSIDERATIONS

Both multicast UDP and TCP are insecure protocols. If the appropriate steps are not taken in the configuration of the network that a bridge is attached to, this could result in a malicious party gaining access to devices connected to the physical CAN network. Therefore, it is important that you configure your network properly before connecting any device to your CAN bus. The most secure configuration procedures are:

1. Disconnect from the Internet. Ensure that there is no connection between any PC in your network and the Internet.
2. Configure your router. In most offices only one router has a connection to the Internet and all other traffic goes through this router. If this router is configured to block all traffic on the port used by the bridge (default 4876), your CAN network will be separated from the Internet.

5 CAN BRIDGE HARDWARE

The CAN-Ethernet bridge uses the standard CAN bus pinout on the male DB9 connector. Refer to the datasheet for the specifications on this connector.

6 USER INTERFACE

The CAN-Ethernet bridge user interface consists of a single push-button and green LED in the front decal.

Holding down the button for more than 5 seconds when the bridge is running will reset the bridge configuration back to factory default settings, and this event is shown by illuminating the front-panel LED briefly.

Holding down the button for at least 5 seconds while powering up the bridge will run the bootloader, allowing the bridge firmware to be updated.

7 CAN BRIDGE USAGE

The CAN-Ethernet bridge is fully plug and play. When the bridge is connected to an Ethernet network it will acquire an IP address, either via DHCP or Auto IP, or by using a previously configured static IP. Once an address has been assigned the bridge will begin operating.

8 NETWORK TOPOLOGIES

The most basic network is a single hardware bridge on the CAN bus with multiple applications connected to the UDP part of the bus, as shown in Figure 1.

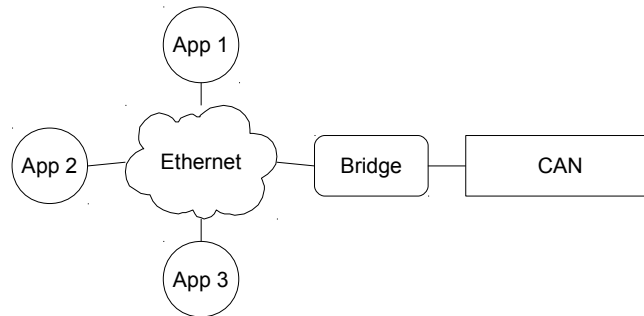

Figure 1: Setup with hardware bridge

When making more advanced networks, the easiest setup is using multiple CAN buses on the same network, as shown in Figure 2. In this case, messages sent on one CAN bus, will also be received by the devices listening on the other bus. In order to create this setup, both bridges should be configured with the same virtual bus, which is the default configuration. When a different virtual bus is given to the two bridges of Figure 2, the CAN buses will have no interaction, so two simple networks as shown in Figure 1 are created.

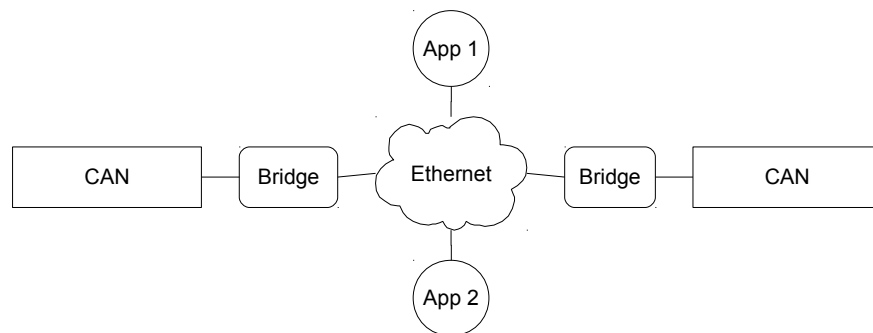

Figure 2: Setup with multiple CAN buses

Another advanced configuration is using multiple bridges on one CAN bus, as shown in Figure 3. This network looks simple and can be quite useful when multiple persons are collecting information from the CAN bus, but it is very easy to create a cyclic network, which is not desired. This often happens because the two Ethernet parts shown in Figure 3 are actually connected, resulting in only one Ethernet part as shown in Figure 4. Having a cyclic network will cause problems, as explained below.

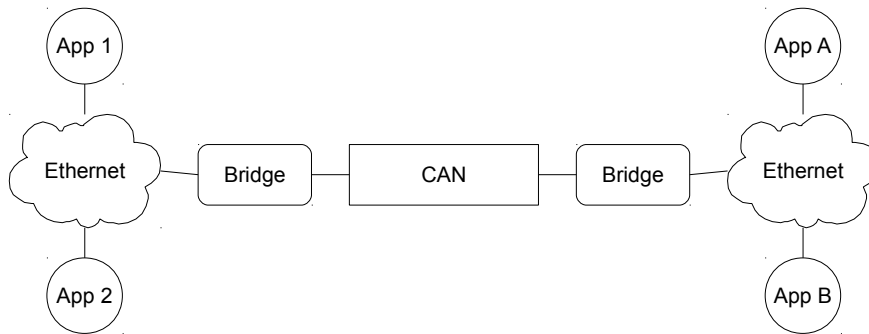

Figure 3: Setup with multiple bridges on one CAN bus

The problem with a cyclic network as shown in Figure 4 is that any message bridged by bridge A via UDP will be bridged back to the CAN bus by bridge B, to be bridged by A again. Therefore, any message will be resent infinitely and soon the CAN bus will be so loaded that most messages get lost. **Creating a cycle in your network causes that network to become unusable and should be avoided.**

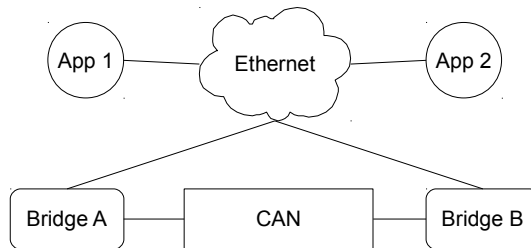

Figure 4: Cyclic setup with multiple bridges on one CAN bus

9 BRIDGE CONFIGURATION

The CAN-Ethernet bridge has a three configurable settings:

- **Static IP** This setting determines whether the bridge should use a static IP address and also allows for the address to be set. This is useful for point-to-point connections where no DHCP server exists on the network.
- **Bus Number** This is the setting that allows you to have multiple virtual CAN busses running simultaneously, with different CAN bridges on the same Ethernet segment
- **CAN Bit rate** This is the Bit rate that the bridge should use to communicate on it's physical CAN bus.

These settings can be changed using the CAN-Ethernet Bridge Configuration Tool described below.

9.1 CAN-ETHERNET BRIDGE CONFIGURATION SOFTWARE

The CAN-Ethernet Bridge Configuration application provides three functions. First, it enables users to modify the Bridge Configuration of the bridges connected to the network. Secondly, it allows users to view the bridges connected to their network and select the bridge corresponding to the virtual network that they wish to use. Third, it allows updating the bridge firmware.

Figure 5 shows a screenshot of the configuration tool.

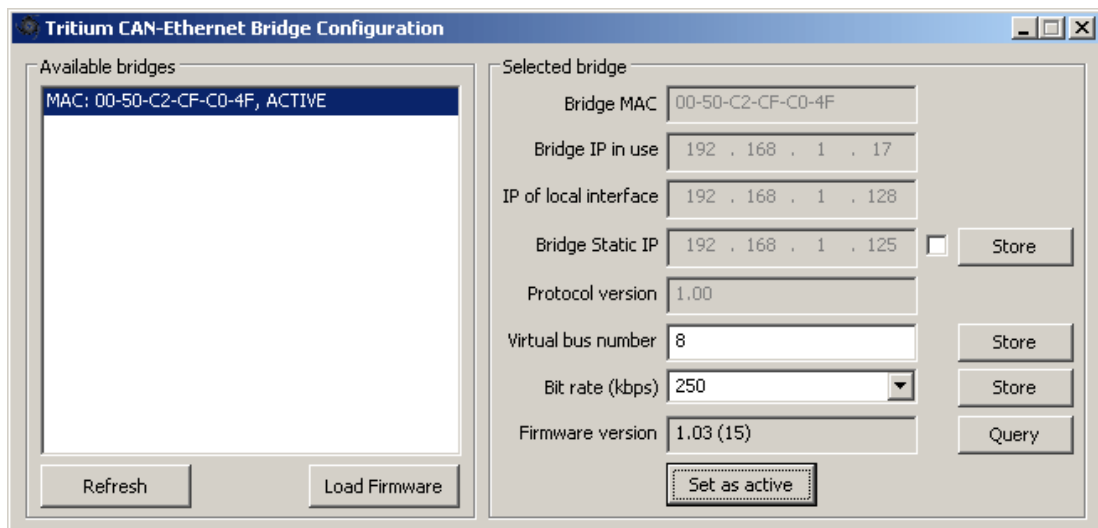

Figure 5: Can-Ethernet Bridge Configuration Tool

The listbox on the left shows detected CAN-Ethernet bridges. Details about the selected bridge are shown on the right. These details are:

- **Bridge MAC** The MAC address of the bridge. This is unique for each bridge, and is fixed in the factory and cannot be changed.
- **Bridge IP in use** The IP address assigned to the bridge by your DHCP server, AutoConf, or manually (if a Static IP is set). This is the IP address

that TCP/IP connections will be made to. If this IP address is not on the same subnet as the IP address of the local machine, TCP/IP connections will not be available and programs that rely on them will not work.

- **IP of local interface** The IP address on the local machine assigned to the interface connected to the network on which the bridge resides. This information is useful for identifying bridges when the PC has multiple network interfaces (eg, wired, wireless). This IP address must be on the same subnet as the bridge in order for TCP/IP connections to be available.
- **Bridge Static IP** The saved static IP address in the Bridge. This is editable when using a Static IP, which is enabled by setting the adjacent check-box. Upon storing the setting the bridge will restart using either the Static IP (when enabled) or an IP attained from the DHCP server (when disabled). Note: the Static IP subnet is not configurable and is automatically set based on the class of the network (A, B or C). The value is set in the bridge by pressing *Store*.
- **Protocol Version** Ethernet communications protocol version.
- **Bus Number** The virtual CAN network that this bridge should connect to. This may be set by modifying the value in the edit box and pressing *Store*.
- **Bit rate** The bit rate of the CAN network that the bridge is connected to. This rate may be set by either selecting a value in the drop-down list, or directly entering the value in the edit box and pressing *Store*.
- **Firmware Version** Bridge firmware version. This can be obtained from the bridge by pressing the *Query* button.

When the Bridge Configuration is changed, the list of bridges will be refreshed. This may take a few seconds. When a bridge is disconnected from the network, it is automatically removed from the list.

The button labelled *Set as active* is used to register the selected bridge and virtual bus for use by all Tritium programs on the machine. Active bridges are identified by the local interface they are connected through (i.e. the local IP address) and their virtual bus number. Thus, it is possible for multiple bridges to be active, e.g. in the network topology shown in Figure 2. A bridge must be set as active when it is first used on a given PC, and again whenever the local IP address of the machine changes. The currently active bridge(s) are labelled as *ACTIVE* in the list.

It should be noted that the configuration tool uses a TCP/IP connection to modify the port, bit rate and Static IP settings on a bridge. Therefore, if the bridge is on a different subnet as the local machine these settings cannot be modified, and this network arrangement is therefore not recommended. It is highly recommended to configure bridges on a LAN with a DHCP server or Static IP configured on the same subnet.

9.2 CAN-ETHERNET BRIDGE FIRMWARE BOOTLOAD WIZARD

The CAN-Ethernet Bridge Loader wizard provides the ability to load updated firmware images into the bridge, to provide new features and functionality. It is accessed by selecting the bridge you wish to load in the CanBridgeConfig utility, then clicking the *Load Firmware* button.

Figure 6 shows a screenshot of the loader tool.

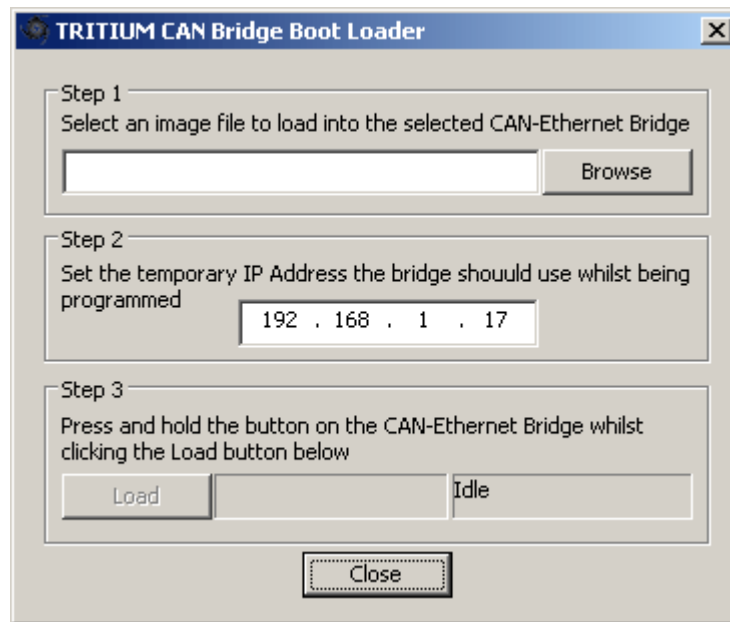

Figure 6: Can-Ethernet Bridge Loader Tool

To use the tool, complete the following steps:

- 1) Download the latest firmware image file (.teb) from the Tritium website
- 2) Run CanBridgeConfig, select the bridge to load, and click *Load Firmware*
- 3) *Browse* to where the image file is saved and select the file
- 4) Check that the temporary IP address that will be assigned is sensible. In most cases the utility will choose a valid address on the same subnet, and the default will not require changing
- 5) Press the *Load* button, and the application will begin waiting for a bridge
- 6) Hold down the button on the bridge front panel
- 7) Apply or cycle power to the bridge while continuing to hold the button, until the loader utility finds the bridge. The button can now be released.
- 8) The loader application will load in the new firmware
- 9) Once the load is complete, press and hold the button on the bridge until the status LED flashes briefly, in order to load factory default settings



USER'S MANUAL

CAN-Ethernet Bridge

TRI82.002 ver 7
8 October 2011

10 REVISION RECORD

<i>REV</i>	<i>DATE</i>	<i>CHANGE</i>
1	1 December 2009	Document creation (STB)
2	19 August 2010	Updated for v2 hardware (JMK)
3	8 December 2010	Updated for new firmware, TCP/IP, etc. (MSM)
4	9 December 2010	Added user interface section (JMK)
5	21 February 2011	Updated port to IANA assignment, modified configuration options in software, added firmware update (JMK)
6	23 August 2011	Added Static IP capabilities. GUI reworked for easier use.(AKR)
7	8 October 2011	Modified loader utility section, as it is now part of the config program instead of separate application (JMK)